

Unmanaged Industrial Gigabit Ethernet Switch

Quick Installation Guide

V1.0

FCC MARKING

This Equipment has been tested and found to comply with the limits for a Class A digital device, pursuant to part 15 of the FCC Rules. These limits are designed to provide reasonable protection against harmful interference when the equipment is operated in a commercial environment. This equipment generates, uses, and can radiate radio frequency energy and, if not installed and used in accordance with the instruction manual, may cause harmful interference to radio communications. Operation of this equipment in a residential area is likely to cause harmful interference in which case the user will be required to correct the interference at his own expense.

This device complies with Part 15 of the FCC Rules. Operation is subject to the following two conditions: (1) this device may not cause harmful interference, and (2) this device must accept any interference received; including interference that may cause undesired operation.

CE MARKING

This equipment complies with the requirements relating to electromagnetic compatibility, EN 55022 class A for ITE, the essential protection requirement of Council Directive 2004/108/EC on the approximation of the laws of the Member States relating to electromagnetic compatibility.

Company has an on-going policy of upgrading its products and it may be possible that information in this document is not up-to-date. Please check with your local distributors for the latest information. No part of this document can be copied or reproduced in any form without written consent from the company.

Trademarks:

All trade names and trademarks are the properties of their respective companies.
Copyright © 2013, All Rights Reserved.



(P/N: 41NE-ISG401F0-A00)

Overview

The unmanaged Industrial Gigabit Ethernet Switch solutions are designed for supporting standard industrial applications without complex setup to make the network truly plug-and-play.

Package Contents

Please verify that the box contains the following items:

- 1 x Industrial Ethernet Switch
- 1 x User Manual
- 1 x 3 pin Terminal Block
- 2 x Wall Mounting Bracket
- 1 x Din-Rail Bracket
- 4 x M4 Screws (for the wall mount plates & DIN CLIP)

Compare the contents of the industrial switch with the standard checklist above. If any item is damaged or missing, please contact the local dealer for service.

Safety Instructions

When a connector is removed during installation, testing, or servicing, or when an energized fiber is broken, a risk of ocular exposure to optical energy that may be potentially hazardous occurs, depending on the laser output power.

The primary hazards of exposure to laser radiation from an optical-fiber communication system are:

- Damage to the eye by accidental exposure to a beam emitted by a laser source.
- Damage to the eye from viewing a connector attached to a broken fiber or an energized fiber.

Documentation Conventions

The following conventions are used in this quick installation guide to emphasize information that will be of interest to the reader.

Danger — The described activity or situation might or will cause *personal injury*.

Warning — The described activity or situation might or will cause *equipment damage*.

Caution — The described activity or situation might or will cause *service interruption*.

Note — The information supplements the text or highlights important points.

Dimension Illustration

5-Port

8-Port

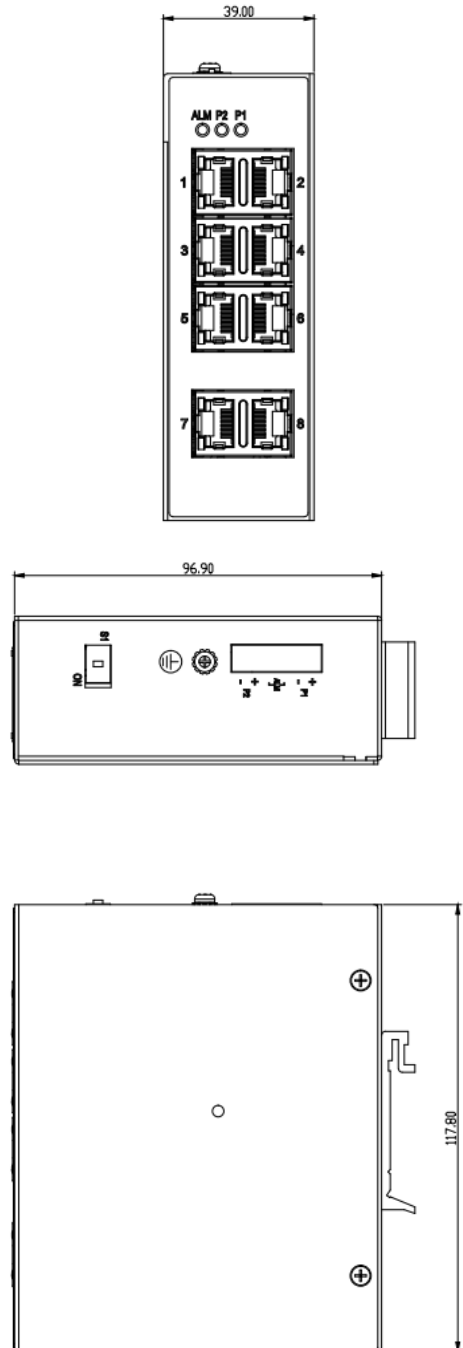
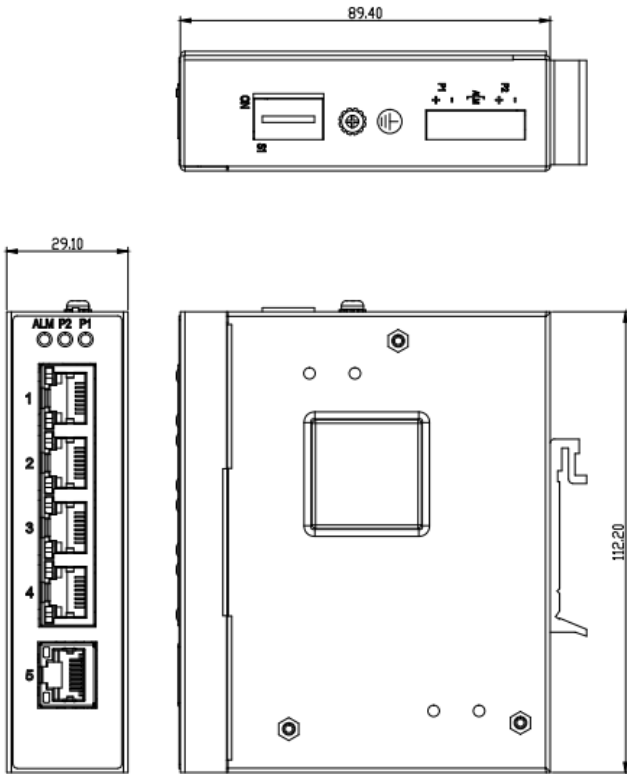

DIN-Rail Mounting

Mounting step:

1. Screw the DIN-Rail bracket on with the bracket and screws in the accessory kit.
2. Hook the unit over the DIN rail.

3. Push the bottom of the unit towards the DIN Rail until it snaps into place.

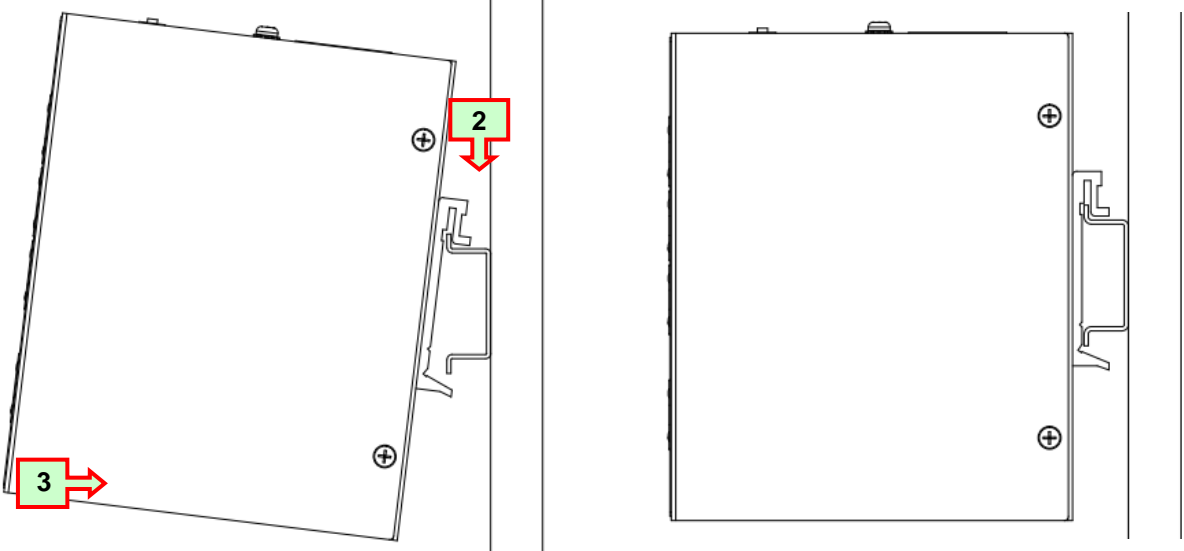

Wall Mounting

Mounting step:

1. Screw on the wall-mount plate on with the plate and screws in the accessory kit.

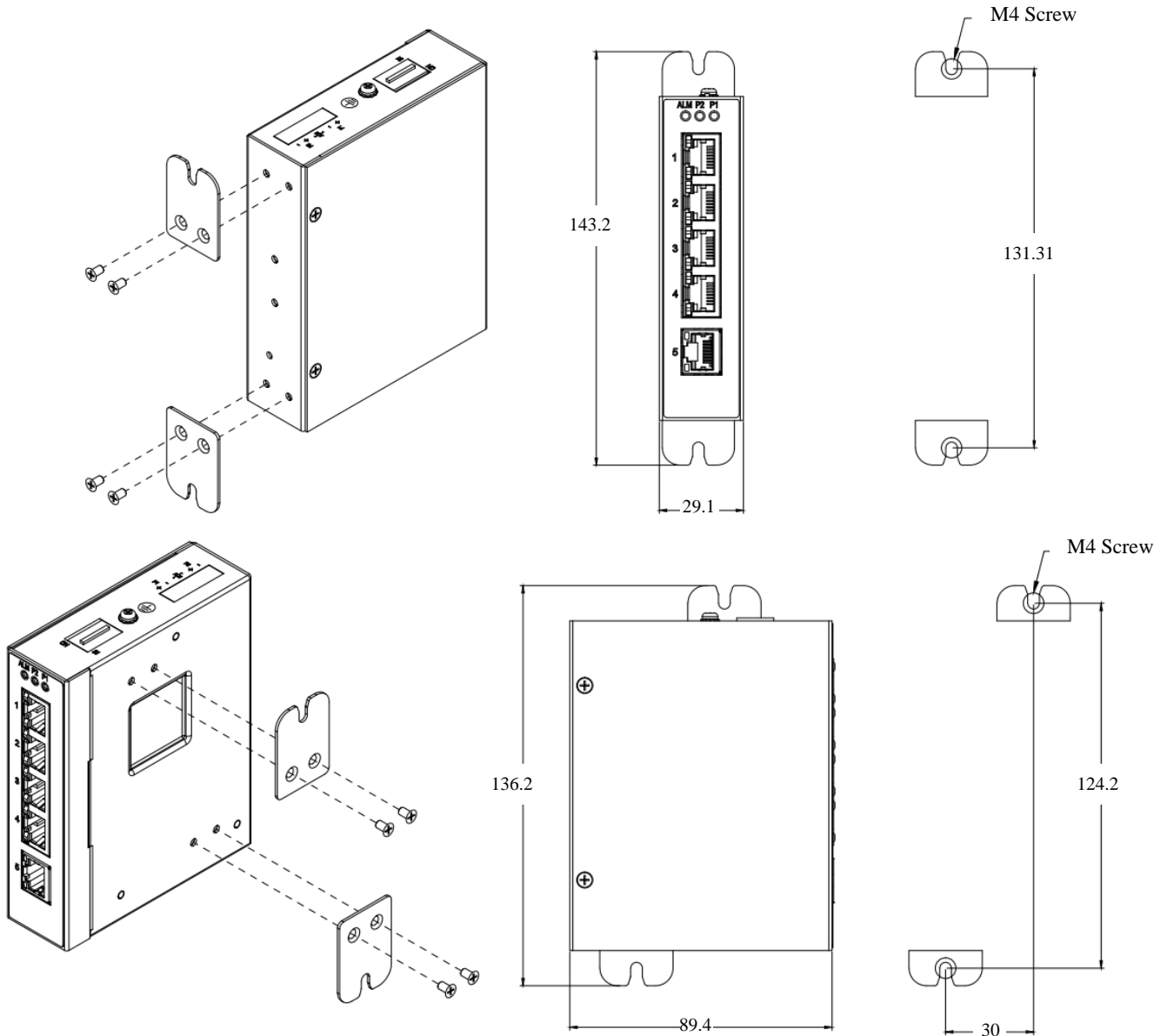

Ground Connecting

This switch must be properly grounded for optimum system performance.

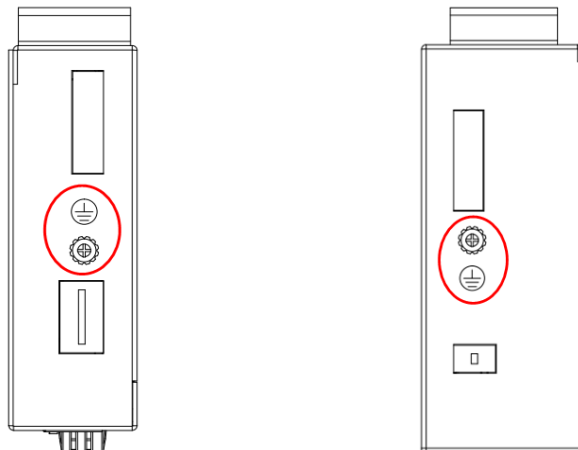

Ethernet Interface Connecting (RJ45 Ethernet)

The switches provide two types of electrical (RJ45) and optical (mini-GBIC) interfaces.

Connecting the Ethernet interface via RJ45:

- To connect to a PC, use a straight-through or a cross-over Ethernet cable,
- To connect the switch to an Ethernet device, use UTP (Unshielded Twisted Pair) or STP (Shielded Twisted Pair) Ethernet cables.

The pin assignment of RJ-45 connector is shown in the following figure and table.

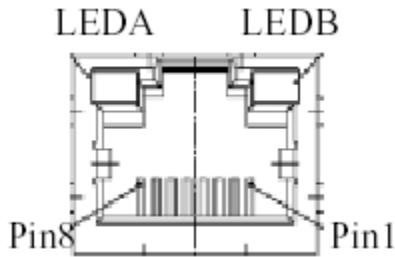

Pin	Assignment
1,2	T/Rx+,T/Rx-
3,6	T/Rx+,T/Rx-
4,5	T/Rx+,T/Rx-
7,8	T/Rx+,T/Rx-

Ethernet Interface Connecting the (Fiber, SFP)

For a 100 Mbps fiber port available, please prepare the LC connectors or SC connectors (with the use of an optional SC-to-LC adapter). They are also available with multimode, single mode, long-haul (for connections up to 120+ km) or special-application transceivers.

For a 1000 Mbps fiber port available, please use the mini-GBIC SFP (small form pluggable). These accept plug in fiber transceivers that typically have an LC style connector. They are available with multimode, single mode, long-haul (for connections up to 80+ km) or special-application transceivers.

For each fiber port there is a transmit (TX) and receive (RX) signal. Please make sure that the transmit (TX) port of the switch connects to the receive (RX) port of the other device, and the receive (RX) port of the switch connects to the transmit (TX) port of the other device when making your fiber optic connections.

DANGER: Never attempt to view optical connectors that might be emitting laser energy. Do not power up the laser product without connecting the laser to the optical fiber and putting the cover in position, as laser outputs will emit infrared laser light at this point.

Power Connecting

The switch can be powered from two power supply (input range 12V – 58V). Insert the positive and negative wires into V+ and V- contact on the terminal block and tighten the wire-clamp screws to prevent the wires from being loosened.

Note: The DC power should be connected to a well-fused power supply.

Alarm Relay Connecting

The alarm relay output contacts are in the middle of the DC terminal block connector as shown in the figure below.

By inserting the wires and set the DIP switch of the respective Port Alarm to “ON”, the relay output alarm will detect any port failures, and form a short circuit.

The alarm relay output is “Normal Open”.

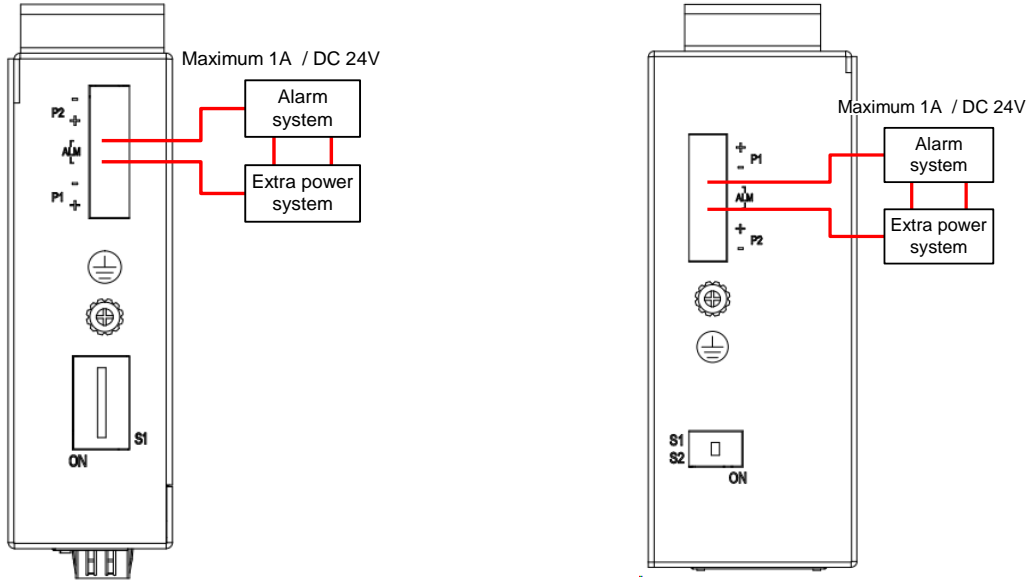

DIP Switch Setting

Pin No#	Status	5-Port (5TX)	5-Port (4TX+1SFP)
Pin 1	ON	To enable the power alarm.	To enable the power alarm.
	OFF	To disable the power alarm.	To disable the power alarm.
Pin 2	ON	To enable Broadcast storm rate limit	To enable Broadcast storm rate limit
	OFF	To disable Broadcast storm rate limit	To disable Broadcast storm rate limit
Pin 3	ON	NOT USED	NOT USED
	OFF	NOT USED	NOT USED
Pin 4	ON	NOT USED	NOT USED
	OFF	NOT USED	NOT USED
Pin 5	ON	NOT USED	NOT USED
	OFF	NOT USED	NOT USED
Pin 6	ON	NOT USED	NOT USED
	OFF	NOT USED	NOT USED

Pin No#	Status	8-Port (8TX)	8-Port (6TX+2SFP)
Pin 1	ON	To enable Broadcast storm rate limit	To enable Broadcast storm rate limit
	OFF	To disable Broadcast storm rate limit	To disable Broadcast storm rate limit
Pin 2	ON	To enable the power alarm.	To enable the power alarm.
	OFF	To disable the power alarm.	To disable the power alarm.

LED Status Indications

LED Name	Indicator /color	Condition
P1	On Green	P1 power line has power
	Off	P1 power line disconnect or does not have supply power
P2	On Green	P2 power line has power
	Off	P2 power line disconnect or does not have supply power
Alarm	On Red	Power failure alarm occurs
	Off	No power failure alarm
Copper port Link/Act	On Green	Ethernet link up but no traffic is detected
	Flashing Green	Ethernet link up and there is traffic detected
	Off	Ethernet link down
Copper port Speed	On Yellow	A 1000Mbps connection is detected
	Off	No link, a 10Mbps or 100 Mbps connection is detected
SFP Link/Act	On Green	Ethernet link up
	Off	Ethernet link down
SFP Speed	On Yellow	SFP port speed 1000Mbps connection is detected.
	Off	No link or a SFP port speed 100Mbps connection is detected.

Technical Specifications

Model	5-Port	8-Port
Ethernet		
Copper RJ45 Ports	10/100/1000 Mbps speed auto-negotiation; MDI/MDIX Auto-crossover	
SFP (pluggable) Ports	100/1000BaseSFP slot	
Fiber port connector	LC typically for fiber (depends on module)	LC typically for fiber (depends on module)
Power		
Power input	Redundant Input Terminals; Reverse power protection	
Input voltage range	12-58 VDC	
Environmental and Compliances		
Operating temperature	-40 to +75°C (cold startup at -40°C) -40 to +85°C Extended version available by request	
Storage temperature	-40 to +85°C	
Humidity	5 to 95% RH (non-condensing)	
Mechanical		
Ingress protection	IP30	
Dimension (without DIN rail clip)	112.2mm(H) x 29.1mm (W) x 89.4mm (D)	117.8mm(H) x 39mm (W) x 96.9mm (D)
Weight	329g	439g
Installation option	DIN-Rail mounting Wall mounting	